

Extrusion

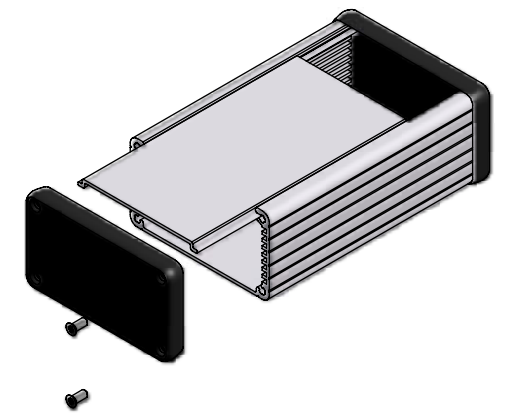

EXTRUSION DESIGNED FOR 75MM WIDE PC BOARD

Slot Details

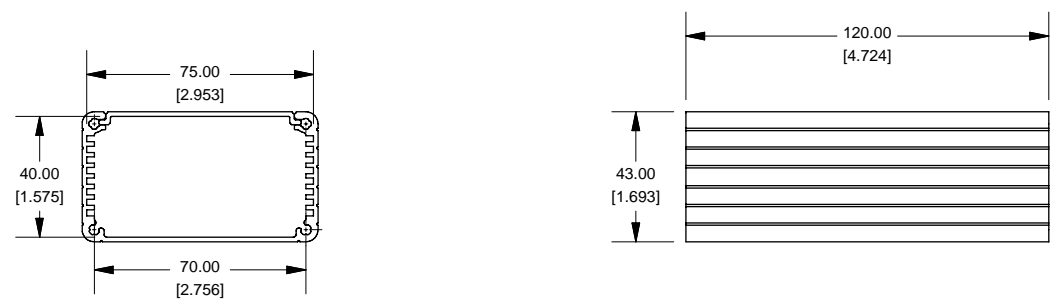
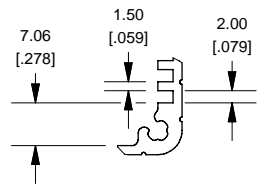

End Plate

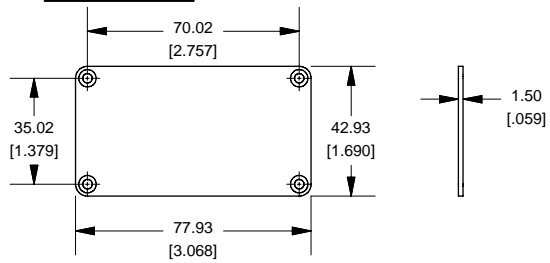

Closed Bezel

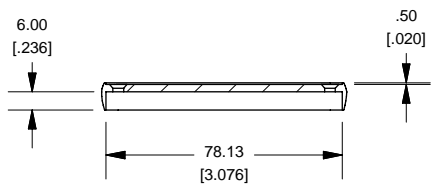
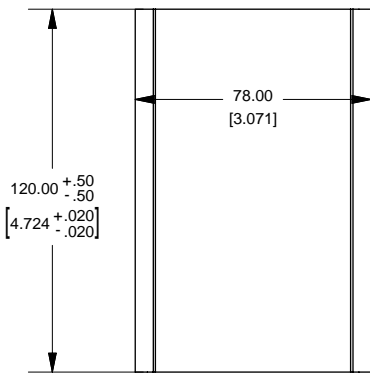
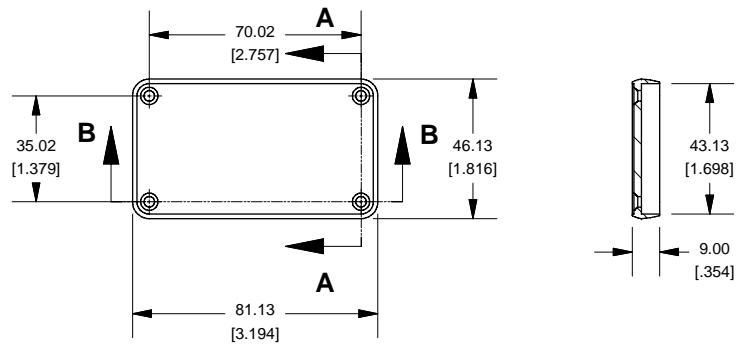

Enclosures can be Factory Modified (Milling, Drilling, Printing etc.)
 Solid models of this enclosure available in STEP or IGES.
 Contact Factory mjm@hammondmfg.com

NOTE	
Purchased assembly includes box, plastic bezels, #6 Taptight screws and self adhesive rubber feet.	
Box made from Extruded Aluminum 6063.	
Bezels made with ABS.	

1455K1202	
PART NUMBERS	
Clear Anodized	1455K1202
Black Anodized	1455K1202BK
ACCESSORIES	
See website for accessories.	

HAMMOND MANUFACTURING™
1455K1202
www.hammondmfg.com