

SIDE VIEW OF BOX

TOP VIEW OF BOX

SECTION A-A

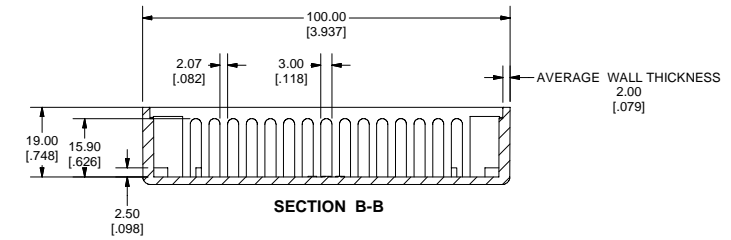

SECTION B-B

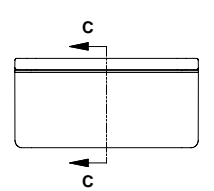

END VIEW OF ASSEMBLY

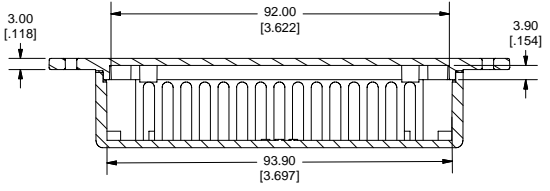

SECTION C-C

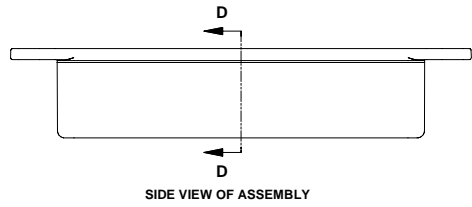

SIDE VIEW OF ASSEMBLY

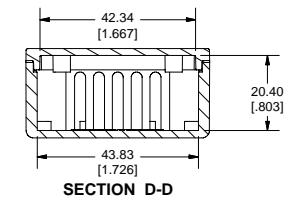

SECTION D-D

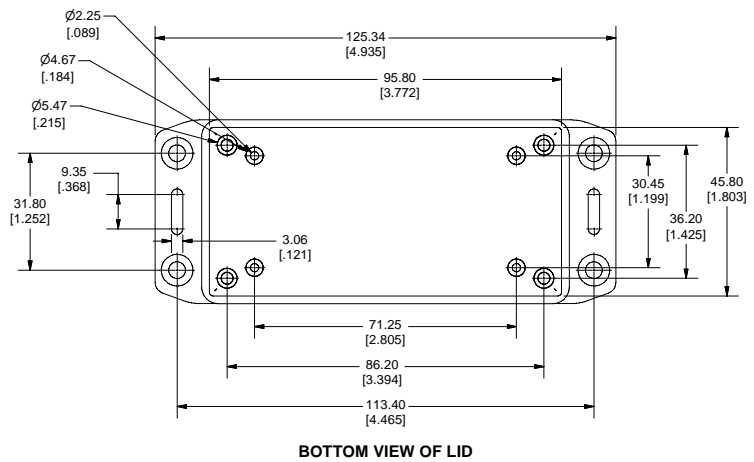

BOTTOM VIEW OF LID

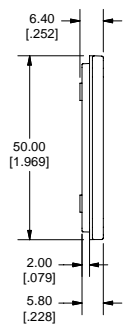

SIDE VIEW OF LID

Note:
 Enclosures can be Factory Modified (Milling, Drilling, Printing etc.)
 Contact Factory mjm@hammondmfg.com for quotes
 Solid models of this enclosure available in STEP or IGES Format.

PART NUMBERS		
1591AFL Flanged Lid Enclosures		
Material	Colour	Part Number
FR ABS	Black	1591AFLBK
UL94 - V0	Grey	1591AFLGY
GP ABS	Black	1591ASFLBK
Accessories		
Description	Part Number	
PC Board Card Adapters	See Accessories Section	
Clear Lids - clear, flame retardant polycarbonate - Lid ONLY	1591AC	
FR ABS Replacement Screws, Flat Head Phillips	1591MS100	
Nickel Plated Pkg of 100	1591MS100BK (Black)	
GP ABS Self Tapping Pkg of 100	1591TS100	
	1591TS100BK (Black)	
Recommended Torque on Fasteners (no lubrication)		
M3 - 0.5 x 10mm Screws	30-40 cN*m	
#4 x 0.5 Screws	30-40 cN*m	

HAMMOND MANUFACTURING™
 1591AFL
www.hammondmfg.com