

OUTLINE & SCHEMATIC DIAGRAMS

Dimensions:	
A	2.500" ±0.063
B	2.810" ±0.063
C	3.450" ±0.125
D	1.870" ±0.063
F	2.440" ±0.063
G	1.250" ±0.063
H	3.380" ±0.063
J	2.810" ±0.063

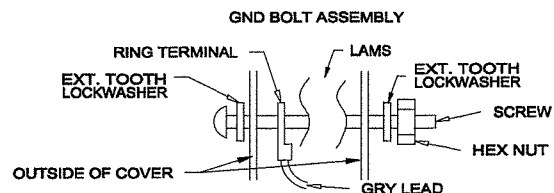
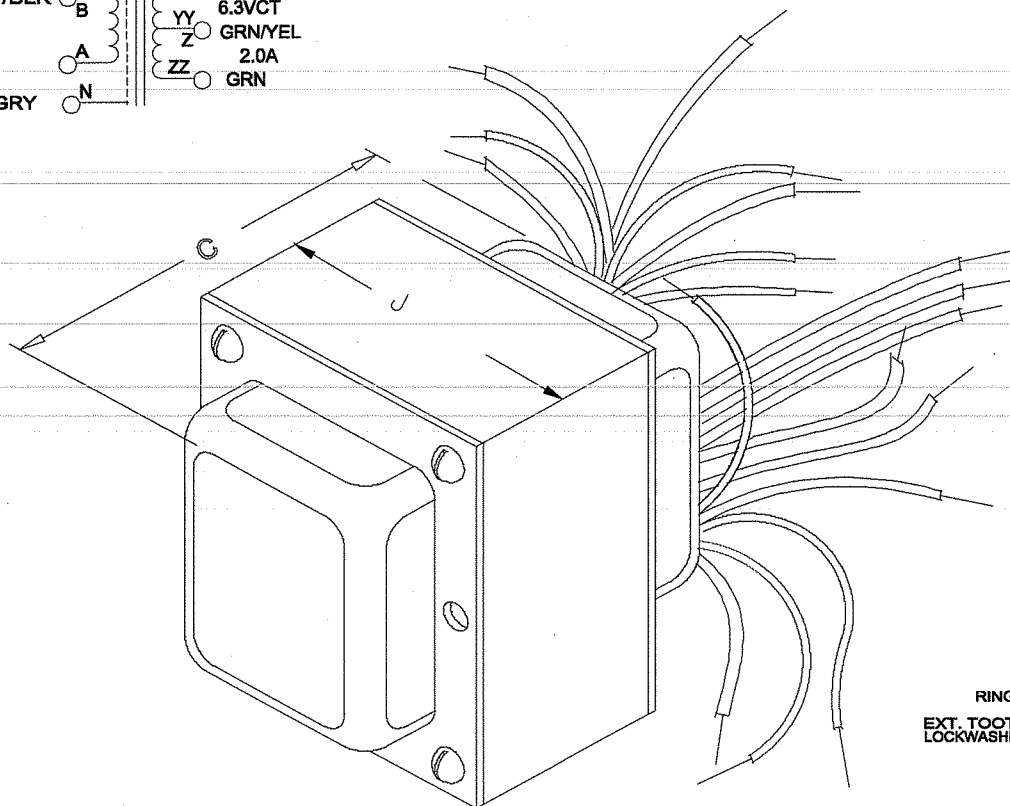
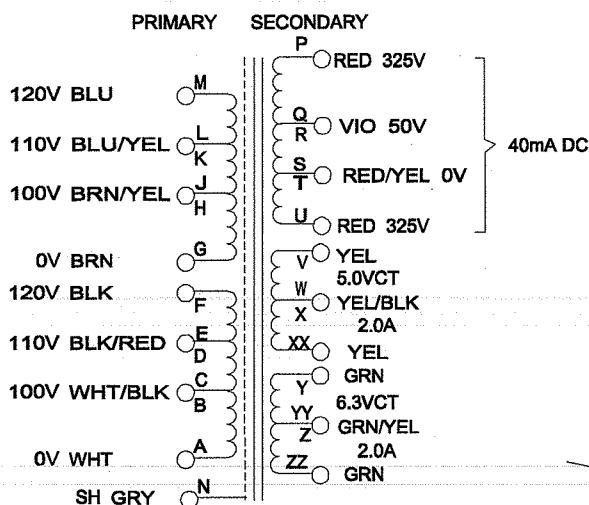
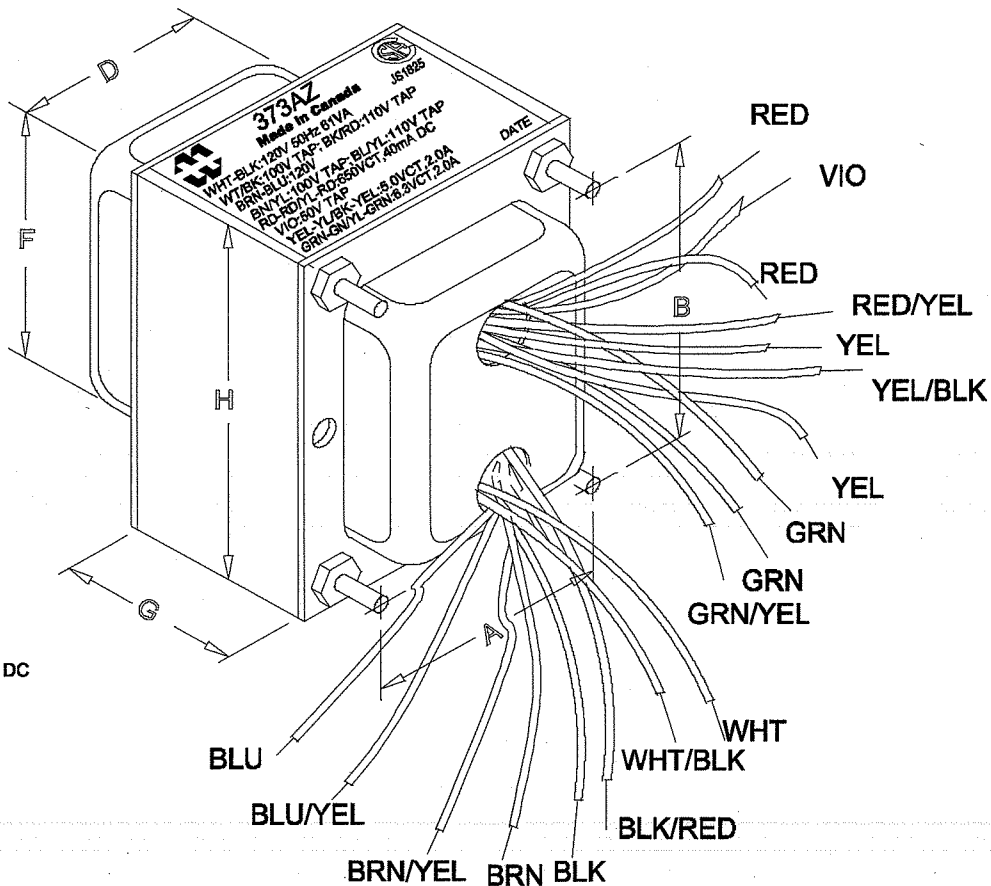

NOTE: ALL LEADS 8" OUT MIN.