

OUTLINE & SCHEMATIC DIAGRAMS

Dimensions:	
A	2.500" ±0.063
B	3.150" ±0.063
C	3.600" ±0.125
D	2.060" ±0.063
F	2.690" ±0.063
G	1.390" ±0.063
H	3.750" ±0.063
J	3.125" ±0.063

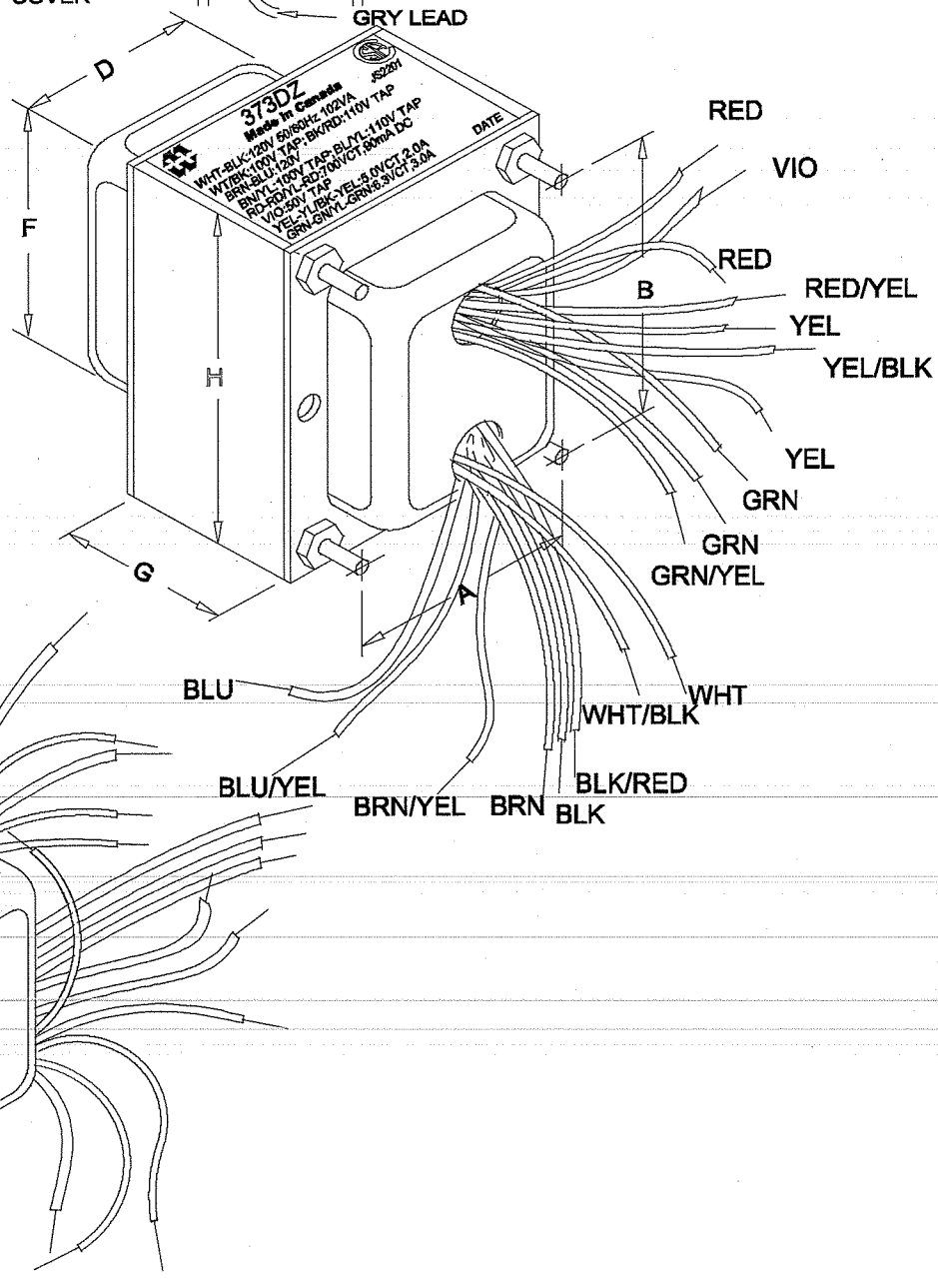
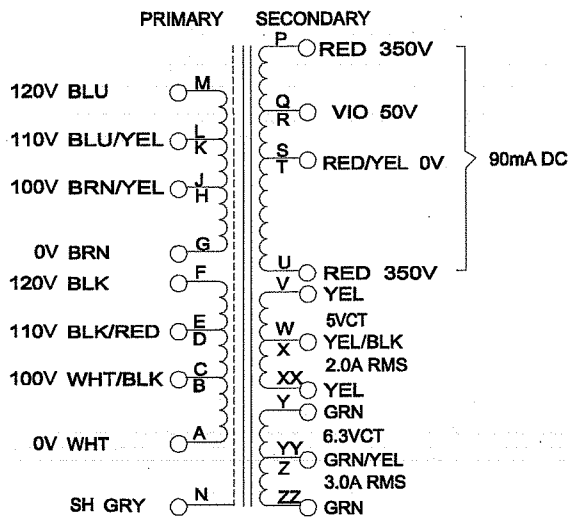
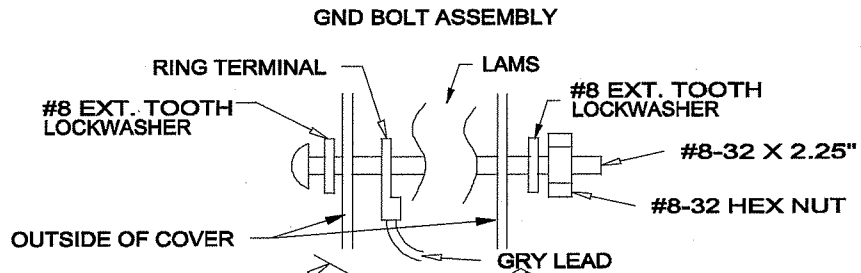

NOTE: ALL LEADS 8" OUT MIN.