

Low Voltage - P.C. Board Mount (160/161 Series)

Power



LOW VOLTAGE - P.C. BOARD VERTICAL MOUNT

- 20 output voltages to choose from (5 - 120VAC R.M.S.)
- Six VA size models available from - .5 to 24 VA
- Vertical mount, split bobbin design.
- Dual winding secondaries, non-concentrically wound
- Low primary to secondary coupling - no electrostatic shield required.
- Choice of economical single primary 115V - 60 Hz only (161 series) or the universal dual primary 115/230V - 50/60 Hz (160 series).
- High insulation - Hipot of 2,000V RMS.
- Class B insulation - 130 degrees C.
- CSA certified and UL recognized.



Part No. Single Pri. 115V	Part No. Dual Pri. 115/230V	Size VA	Secondary (RMS)	
			Series	Parallel
161C10	-	0.5	10V C.T. @ 50ma	5V @ 100ma
161D10	160D10	1	10V C.T. @ 90ma	5V @ 180ma
161FA10	160F10	1.2	10V C.T. @ 120ma	5V @ 240ma
161GA10	160G10	4.4	10V C.T. @ 440ma	5V @ 880ma
161J10	160J10	10	10V C.T. @ 1A	5V @ 2A
161H10	160H10	24	10V C.T. @ 2.4A	5V @ 4.8A
161C12	-	0.5	12.6V C.T. @ 40ma	6.3V @ 80ma
161D12	160D12	1	12.6V C.T. @ 70ma	6.3V @ 140ma
161FA12	160F12	1.2	12.6V C.T. @ 100ma	6.3V @ 200ma
161GA12	160G12	4.4	12.6V C.T. @ 350ma	6.3V @ 700ma
161K12	160K12	10	12.6V C.T. @ 800ma	6.3V @ 1.6A
161H12	160H12	24	12.6V C.T. @ 2A	6.3V @ 4A
161C16	-	0.5	16V C.T. @ 31.3ma	8V @ 62.5ma
161D16	160D16	1	16V C.T. @ 55ma	8V @ 110ma
161EA16	160E16	1.2	16V C.T. @ 75ma	8V @ 150ma
161FA16	160F16	4.4	16V C.T. @ 260ma	8V @ 520ma
161G16	160G16	10	16V C.T. @ 640ma	8V @ 1.28A
161H16	160H16	24	16V C.T. @ 1.5A	8V @ 3A
161D20	160D20	1	20V C.T. @ 45ma	10V @ 90ma
161EA20	160E20	1.2	20V C.T. @ 60ma	10V @ 120ma
161FA20	160F20	4.4	20V C.T. @ 220ma	10V @ 440ma
161G20	160G20	10	20V C.T. @ 500ma	10V @ 1A
161H20	160H20	24	20V C.T. @ 1.2A	10V @ 2.4A
161D24	160D24	1	24V C.T. @ 35ma	12V @ 70ma
161E24	160E24	1.2	24V C.T. @ 50ma	12V @ 100ma
161F24	160F24	4.4	24V C.T. @ 180ma	12V @ 360ma
161G24	160G24	10	24V C.T. @ 450ma	12V @ 900ma
161H24	160H24	24	24V C.T. @ 1A	12V @ 2A
161D28	160D28	1	28V C.T. @ 30ma	14V @ 60ma
161E28	160E28	1.2	28V C.T. @ 40ma	14V @ 80ma
161F28	160F28	4.4	28V C.T. @ 160ma	14V @ 320ma
161G28	160G28	10	28V C.T. @ 360ma	14V @ 720ma
161H28	160H28	24	28V C.T. @ 800ma	14V @ 1.6A
161D34	160D34	1	34V C.T. @ 25ma	17V @ 50ma
161E34	160E34	1.2	34V C.T. @ 35ma	17V @ 70ma
161F34	160F34	4.4	34V C.T. @ 125ma	17V @ 250ma
161G34	160G34	10	34V C.T. @ 300ma	17V @ 600ma
161H34	160H34	24	34V C.T. @ 700ma	17V @ 1.4A
161D40	160D40	1	40V C.T. @ 20ma	20V @ 40ma
161E40	160E40	1.2	40V C.T. @ 30ma	20V @ 60ma
161F40	160F40	4.4	40V C.T. @ 110ma	20V @ 220ma
161G40	160G40	10	40V C.T. @ 250ma	20V @ 500ma
161H40	160H40	24	40V C.T. @ 600ma	20V @ 1.2A
161D56	160D56	1	56V C.T. @ 15ma	28V @ 30ma
161E56	160E56	1.2	56V C.T. @ 20ma	28V @ 40ma
161F56	160F56	4.4	56V C.T. @ 80ma	28V @ 160ma
161G56	160G56	10	56V C.T. @ 180ma	28V @ 360ma
161H56	160H56	24	56V C.T. @ 420ma	28V @ 840ma
161D120	160D120	1	120V C.T. @ 8ma	60V @ 16ma
161E120	160E120	1.2	120V C.T. @ 10ma	60V @ 20ma
161F120	160F120	4.4	120V C.T. @ 35ma	60V @ 70ma
161G120	160G120	10	120V C.T. @ 85ma	60V @ 170ma
161H120	160H120	24	120V C.T. @ 200ma	60V @ 400ma



CANADA
Guelph, Ontario (519) 822-2960
St. Laurent, Quebec (514) 343-9010
USA
Cheektowaga, NY (716) 630-7030

www.hammondmfg.com



EUROPE
Basingstoke, UK 01256 812812

AUSTRALIA
Queenstown, Australia 61-8-8240-2244

Low Voltage - P.C. Board Mount (160/161 Series)

Power

Single Primary - 161 Series

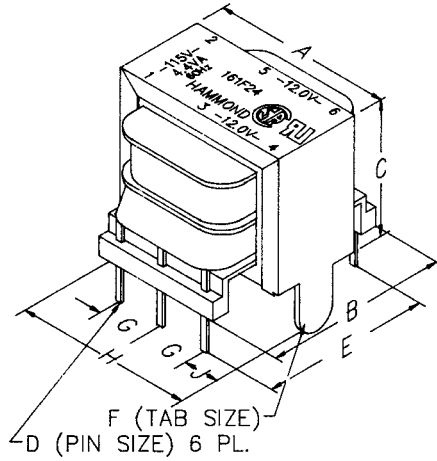

Dual Primary - 160 Series

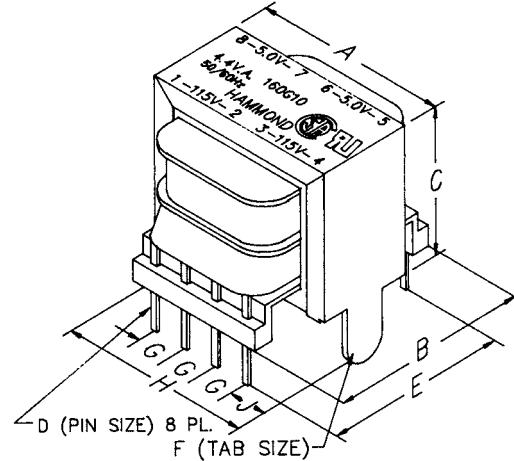

Single Primary - 161 Series Schematic

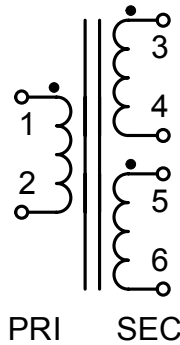

Dual Primary - 160 Series Schematic

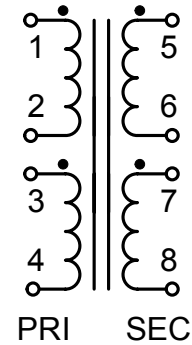

Single Primary - Dimension Table

(VA) Size	Dimensions (Inches)									
	A	B	C	D	E	F	G	H	J	
0.5	1.00	0.94	0.84	0.25 sq.	0.78	N/A	0.2	N/A	N/A	
1	1.00	1.38	0.83	.018 x .041	1.20	N/A	0.26	N/A	N/A	
1.2	1.38	1.19	1.22	.018 x .041	1.00	N/A	0.31	N/A	N/A	
4.4	1.69	1.25	1.45	.018 x .041	1.10	.125 x .03	0.40	1.67	0.44	
10	1.94	1.44	1.69	.018 x .041	1.30	.188 x .03	0.40	1.89	0.55	
24	1.63	2.25	1.38	.018 x .041	2.10	N/A	0.40	N/A	N/A	

Dual Primary - Dimension Table

(VA) Size	Dimensions (Inches)									
	A	B	C	D	E	F	G	H	J	
1	1.00	1.38	0.83	.018 x .041	1.20	N/A	0.20	N/A	N/A	
1.2	1.38	1.19	1.22	.018 x .041	1.00	N/A	0.20	N/A	N/A	
4.4	1.69	1.25	1.45	.018 x .041	1.10	.125 x .03	0.25	1.67	0.46	
10	1.94	1.44	1.69	.018 x .041	1.30	.188 x .03	0.25	1.89	0.57	
24	1.63	2.25	1.38	.018 x .041	2.10	N/A	0.25	N/A	N/A	

EUROPE

Basingstoke, UK 01256 812812

AUSTRALIA

Queenstown, Australia 61-8-8240-2244

www.hammondmfg.com



CANADA

Guelph, Ontario (519) 822-2960
St. Laurent, Quebec (514) 343-9010

USA

Cheektowaga, NY (716) 630-7030

