

ASSEMBLY - TOP VIEW

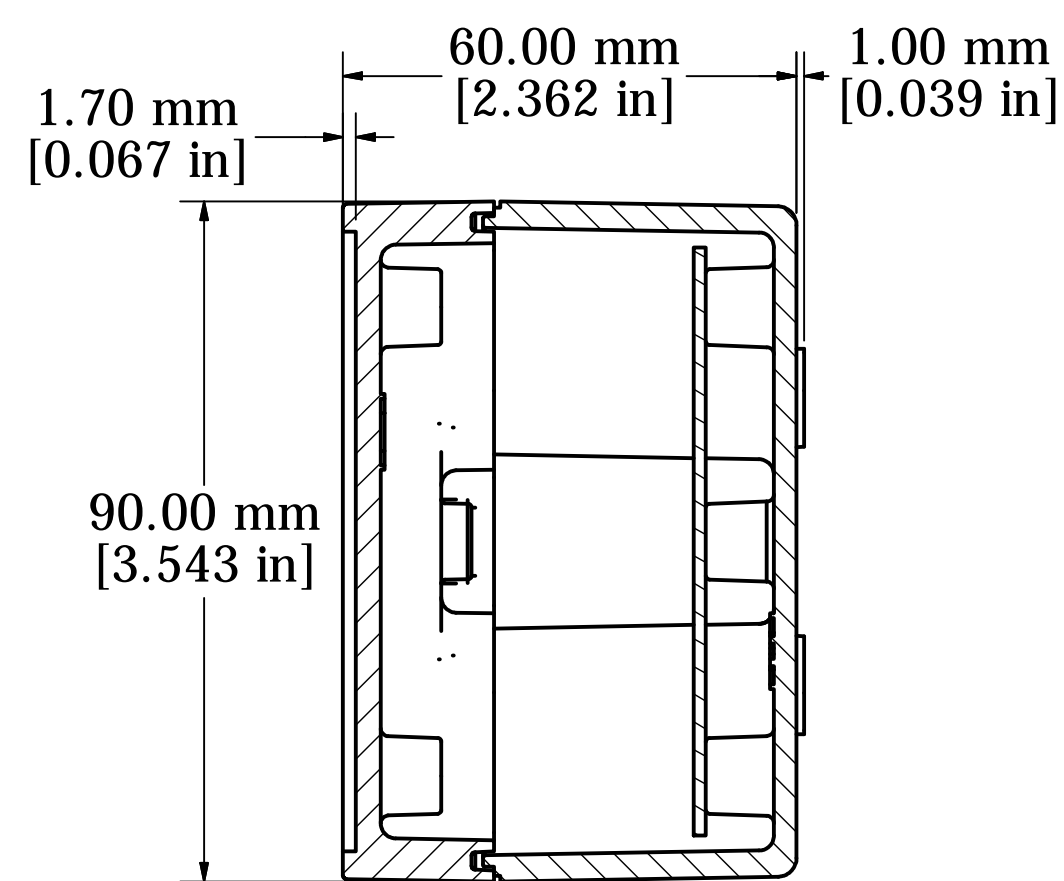

SECTION A-A

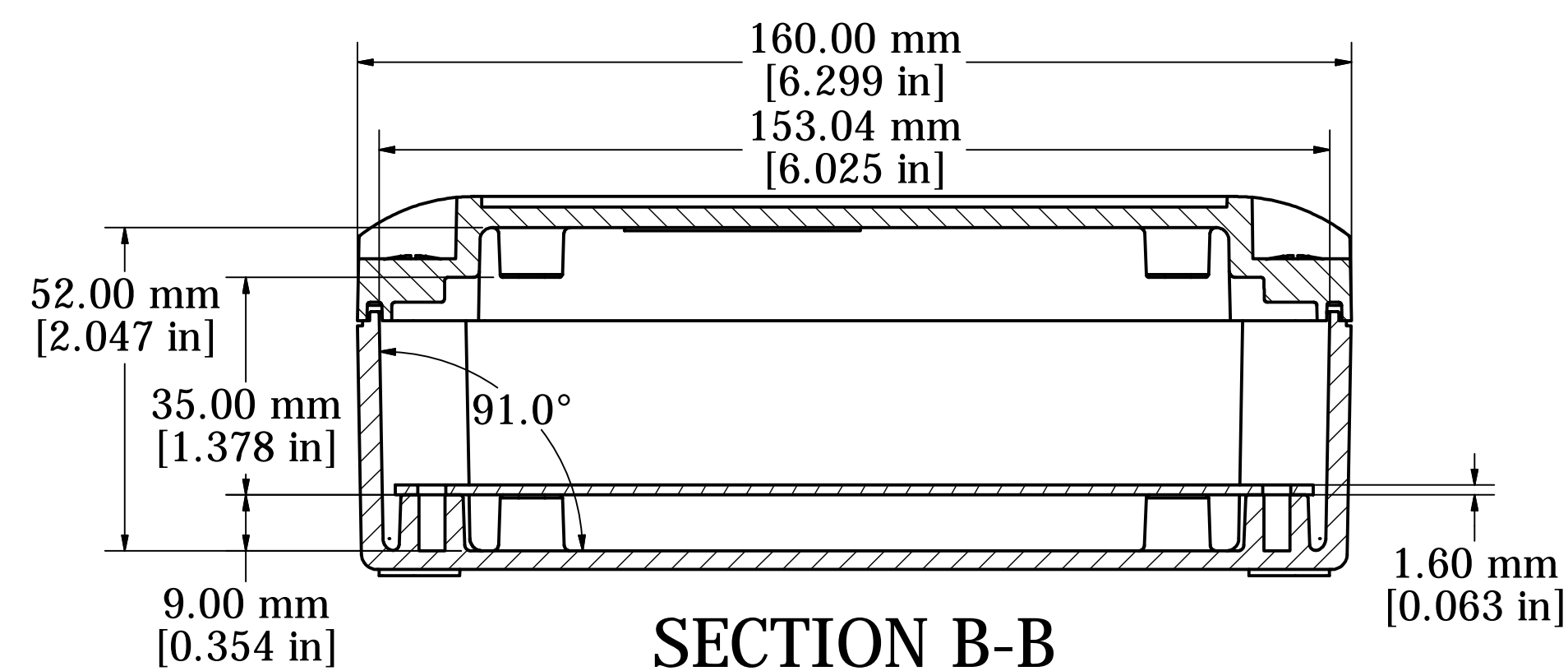

SECTION B-B

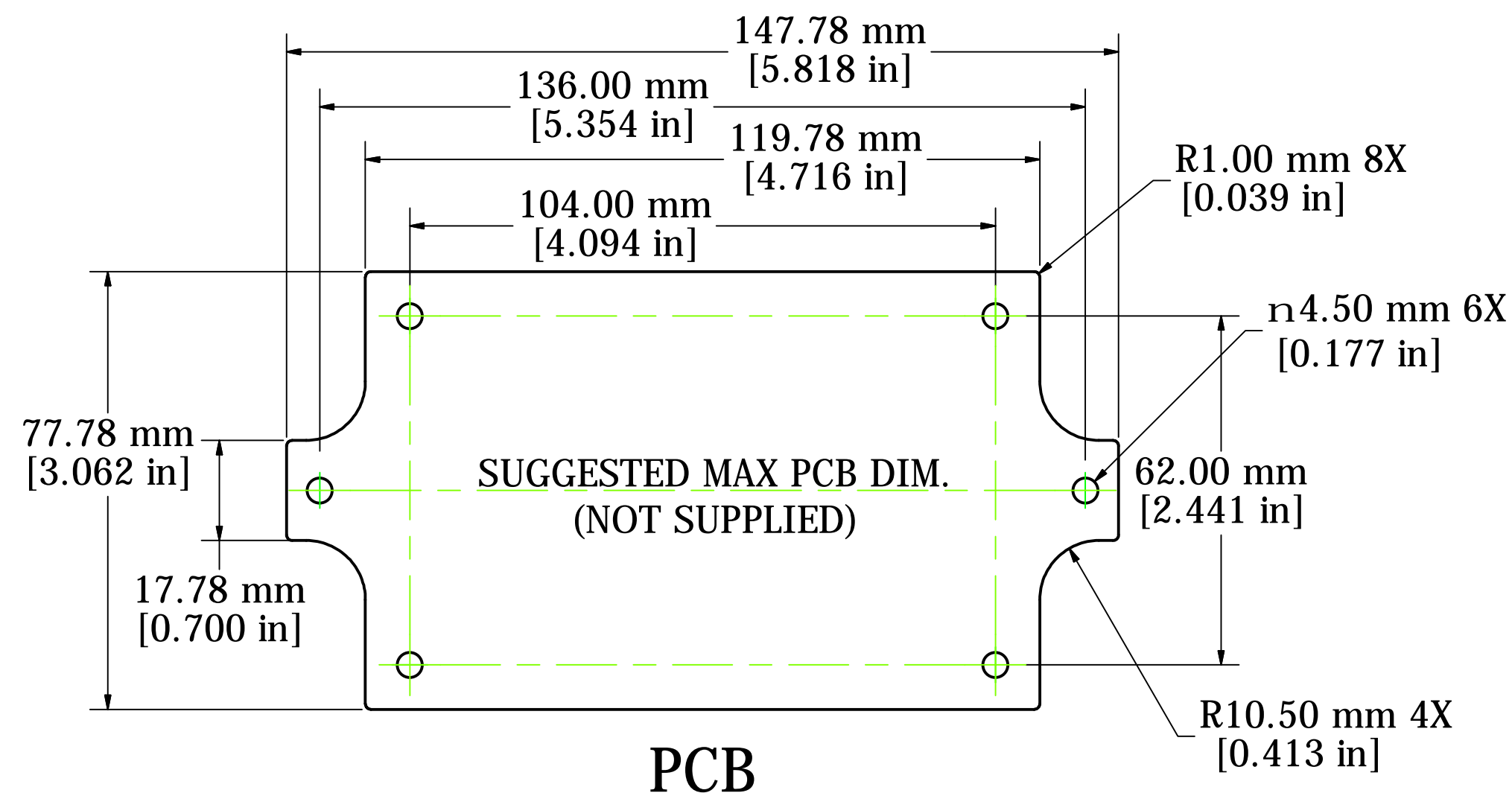

PCB

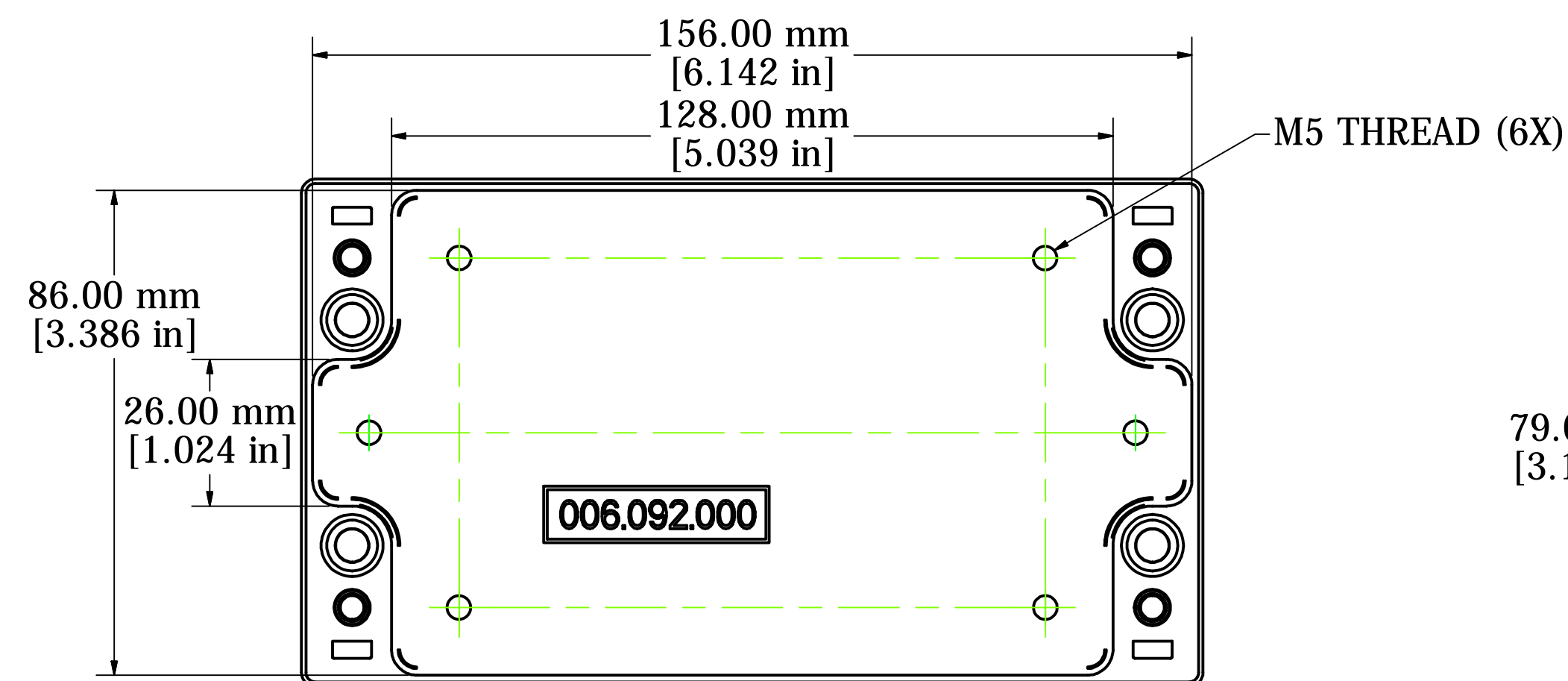

BOX - INSIDE VIEW

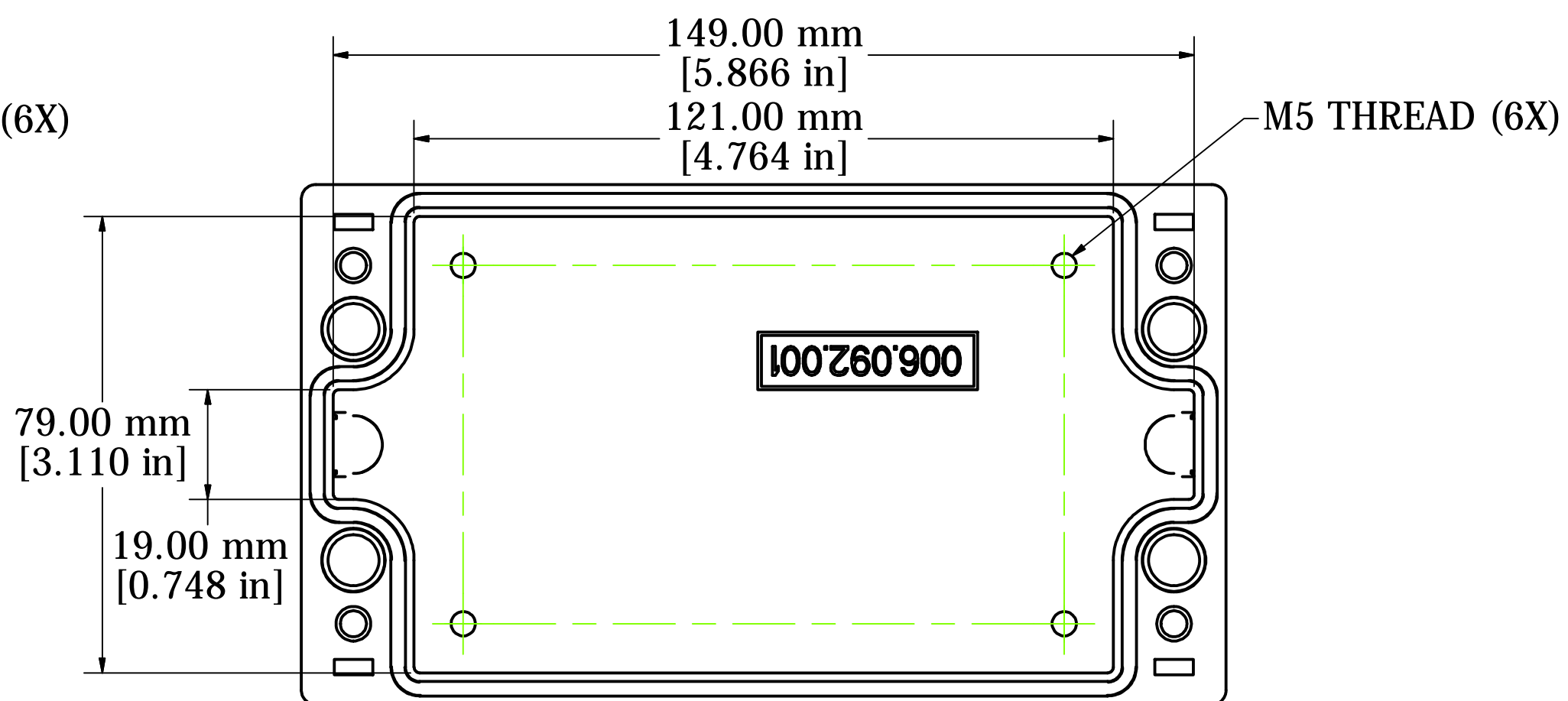

LID - INSIDE VIEW

Enclosures can be Factory Modified ( Milling, Drilling, Printing etc. )  
 Contact Factory [mjm@hammondmfg.com](mailto:mjm@hammondmfg.com) for quotes  
 Solid models of this enclosure available in STEP or IGES.

NOTE
<b>Purchased Assembly includes:</b>
Top and Bottom Cover (Die-cast aluminum G Al Si 12 / DIN 1725)
4 Captive Stainless Steel Screws.
Standard Powder Coated (Silky Grey RAL 7040)
POM Design Covers
Integrated Lid Supports



**HAMMOND  
 MANUFACTURING™**

**R191-092-000**

[www.hammondmfg.com](http://www.hammondmfg.com)