

NOTES

- MATERIAL - EXTRUDED ALUMINUM CASE
 - 6, 14 GAUGE WIRE CORD
 - ON/OFF SWITCH

- FOR COMMERCIAL AND INDUSTRIAL USE
 -INCLUDES 15 AMP, 120 VOLT RESETTABLE CIRCUIT
 -CSA CERTIFIED
 -3 LED INDICATOR LIGHTS FOR POWER, PROTECTION, AND FAULTS

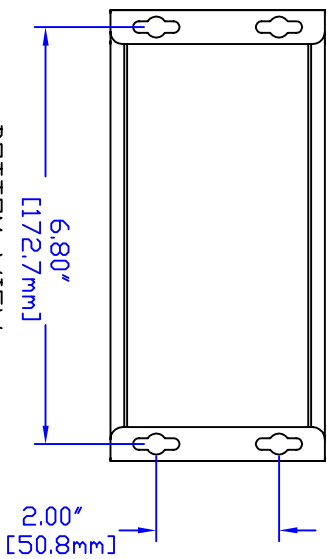

BOTTOM VIEW

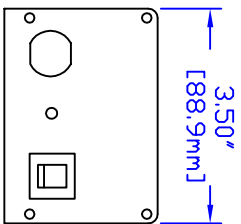

L.SIDE VIEW

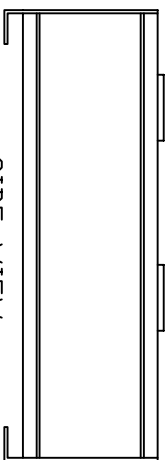

SIDE VIEW

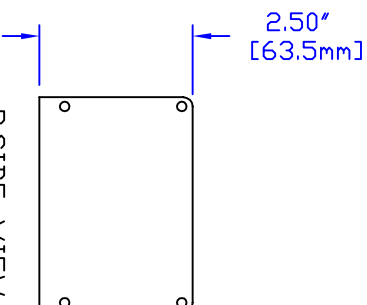

R.SIDE VIEW

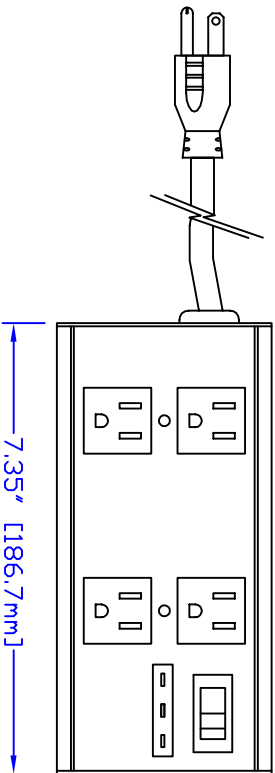

TOP VIEW

- FOR ANY MODIFICATIONS PLEASE PHONE OR FAX FOR AN IMMEDIATE QUOTATION.

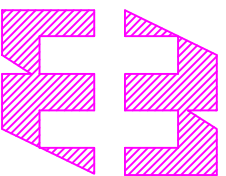

HAMMOND MANUFACTURING

ZT1001-4

website: www.hammondmf.com