

**TOP VIEW**

**SECTION A-A**

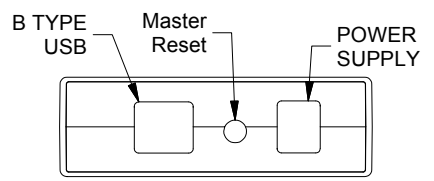

**UNO/101 PANEL**

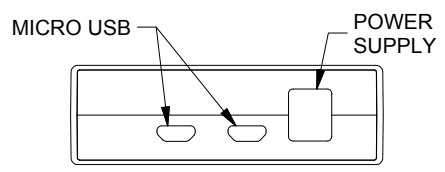

**LEONARDO / M0 PRO PANEL**

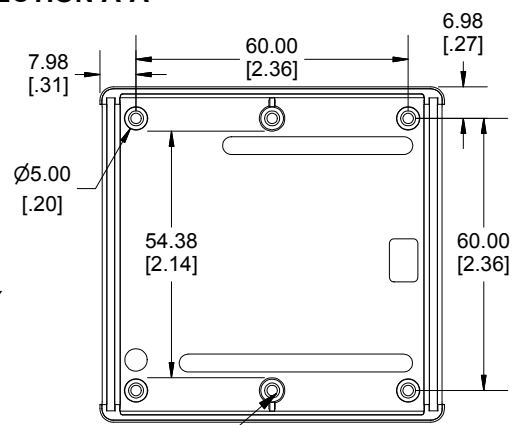

**INSIDE TOP**

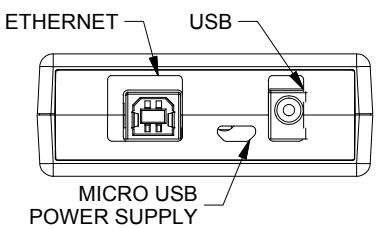

**YUN FRONT VIEW**

ACCEPTS #4 SELF-TAPPING SCREW

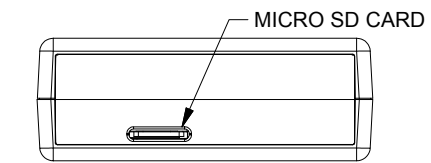

**YUN BACK VIEW**

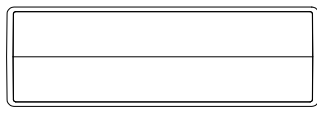

**BACK COVER PANEL**

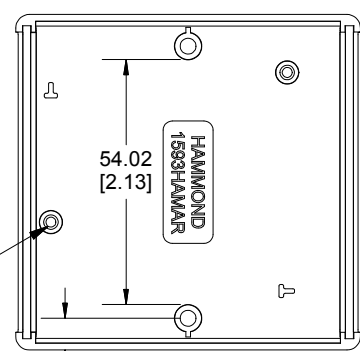

**INSIDE BOTTOM**

ACCEPTS M2.6 SELF-TAPPING SCREW

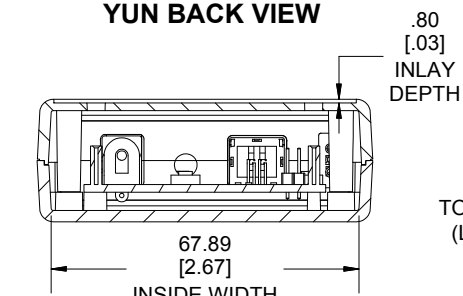

**SECTION B-B**

NOTE:  
PANELS CAN BE SWAPPED OUT TO ACCOMMODATE ARDUINO BOARDS (LEONARDO, YUN, UNO, M0 PRO, 101)

Enclosures can be Factory Modified ( Milling, Drilling, Printing etc.)  
Contact Factory [njm@hammondmfg.com](mailto:njm@hammondmfg.com) for quotes  
Solid models of this enclosure available in STEP or IGES.

**NOTE**

Purchased assembly includes top and bottom cover, 3 front panels (works with Arduino YUN, UNO/101, Leonardo / M0 PRO), 2 rear Panels (one blank and one that works with YUN micro SD card), 2 cover screws, 2 screws to secure Arduino board and 4 rubber feet.

**Recommended Cover Screw Torque - 57lbf-in ( 40cN-m)**

PART NUMBERS		
1593HAMAR2		
Translucent Blue Enclosure		1593HAMAR2TBU
ACCESSORIES		
Cover Screws #4 X 1/2" Self-Tapping (100 Pkg)		1591TS100 1591TS100BK (Black)
P.C. Board Screws M2.6 X 6mm Self-Tapping		SC519-50 (Pkg 50)
Clear Rubber Feet (Pkg 24)		1421T6CL
1593AR STD FLAT PANEL (SINGLE PANEL)	Translucent Blue	1593ARL1TBU-B
1593AR STD CONTOURED PANEL (SINGLE PANEL)	Translucent Blue	1593ARL2TBU-B
1593HAMAR UNO PANEL KIT (FRONT & REAR PANEL)	Translucent Blue	1593ARL3TBU-B
1593HAMAR YUN PANEL KIT (FRONT & REAR PANEL)	Translucent Blue	1593ARL4TBU-B
1593HAMAR LEO/M0 PRO PANEL KIT (FRONT & REAR PANEL)	Translucent Blue	1593ARL6TBU-B
1593HAMAR 101 PANEL KIT (FRONT & REAR PANEL)	Translucent Blue	1593ARL7TBU-B

**HAMMOND MANUFACTURING**

**1593HAMAR2**

[www.hammondmfg.com](http://www.hammondmfg.com)

Dimensions:  
mm  
[inches]